

A Comparative Study of DTC-SVM and FOC-SVM Control Techniques of PMSM

Zaid H. Al-Tameemi, Fadhel A. Jumaa, Haider K. Latif,
Mohammed K. Abbas and Hussam M. Almkhtar

Technical College of Al-Mussaib, Al-Furat Al- Awsat Technical University, Babylon, Iraq

Abstract: Permanent Magnet Synchronous Motors (PMSM) can be utilized directly in place of the Induction Motors (IM) for several industrial applications, since, it is characterized by high efficiency, high power factor and high power compared to IM. Generally, permanent magnet synchronous motors are currently utilized in applications which necessitate fast torque response as well as higher-performance operation of the machine. In order to achieve such features, various control techniques including Vector Control (VC)/Field Oriented Control (FOC) and Direct Torque Control (DTC) are utilized. This study presents simulation of these respective methods to comprehend the impact of each technique on dynamic performance of permanent magnet synchronous motors. MATLAB /Simulink environment has been used to implement this study under dynamic response. In this study, the behavior of PMSM will be studied under the above methods by using the MATLAB/Simulink environment.

Key words: PMSM, direct torque control method, field oriented control method, response, methods, technique

INTRODUCTION

In the last few years, permanent magnet synchronous motor has gained a considerable attention in the industries and academic world (Kouro *et al.*, 2009). Practically, PMSM is considered more desirable than induction motors with respect to high duty factor industrial applications such as pump, fan and compressor because of its high efficiency, subordinate life cycle, high power factor and less sensitivity to supply frequency and voltage deviations (Zhang *et al.*, 2010). In permanent magnet, synchronous motors the rotor winding are replaced by permanent magnets. A Permanent Magnet Synchronous Machine (PMSM) is fundamentally AC machine with winding distributed in the stator slots, so that, the flux that is created by the stator current is approximately sinusoidal.

The control of High-performance motor is characterized by the smooth rotation over the entire speed range of the motor drive, the full torque control at zero speed and the fast acceleration and deceleration (Bodson *et al.*, 1998). In this regard, various methods have been used such as Vector Control (VC)/Field Oriented Control (FOC) and Direct Torque Control (DTC). In order to achieve a good performance of permanent magnet synchronous motor. Therefore, this study will shed light on analyzing the impact of each method on permanent magnet synchronous motor. MATLAB/Simulink environment will have utilized to conduct this study.

MATERIALS AND METHODS

Mathematical model of PMSM: Permanent magnet synchronous motor is considered as important type of AC machines in which the rotor magnetization can be created by permanent magnets that related to the rotor. The modelling of PMSM is required for proper simulation of the system. Various mathematical models have been projected for several applications including dq0 Model and abc model. A d-q Model gained a considerable attention in the engineering control design because of its simplification of the overall system equations and to separate rotor field about stator field. The d-q Model has been developed on rotor reference frame as shown in the Fig. 1. The mathematical equations of PMSM in rotor frame can be written as follows:

$$u_s = R_s i_s + \frac{d}{dt} \phi + j \omega \phi$$
$$\phi = (L_d i_d + \phi) + j L_q i_q$$

u_s stator voltage vector R_s stator resistance i_s , i_d , i_q stator current vector, d-axis and q-axis component ω rotor speed ϕ stator flux vector L_d , L_q d-axis and q-axis inductance ϕ permanent magnet flux T_e is the electromagnetic torque p number of pole pairs.

Control techniques of PMSM: Permanent magnet synchronous motor can be driven by using variable frequency drive that that enable it to run at different

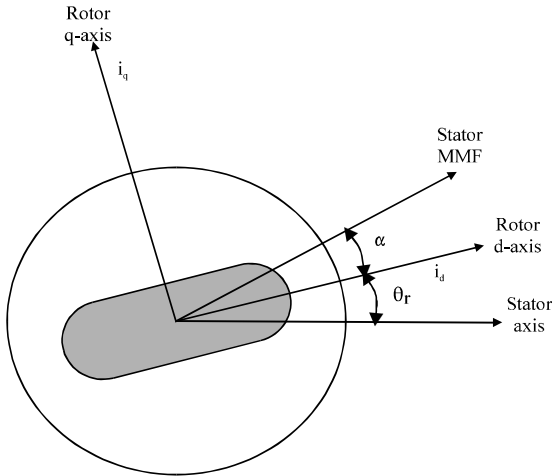

Fig. 1: Motor axis

speed conditions (Krishna and Rao, 2011). Control techniques of motors can be classified into two main categories depending on quantities they control such as scalar control and vector control methods as illustrated.

Scalar: This technique can be employed to adjust the motor frequency in the help of control the stator voltage amplitude and frequency of the respective motor. It has noticed that the proportion of the stator voltage with respect to frequency has to be kept constant that is called as V/F control of AC motor drives (Behera *et al.*, 2014). This method is utilized in the places where many motors are driven in parallel using solitary inverter (Panda, 2014).

Vector control: This technique depends mainly on the amplitude and position of the controlled space vector. Such relations are considered effective even in the transient situations where coupled with magnitude of the rotor and stator flux angle between them is taken in consideration as well (Panda, 2014).

Field oriented control method: Filed oriented control has been invented in the beginning of 1970s. It shows that induction motors can be controlled like excited DC motor in the separate manner as well as it contributed to bringing a revitalization in the high performance control of AC motors. It is worth mentioning that filed oriented control technique is applicable to both induction and synchronous motors (Kaewjinda and Konghirun, 2007; El Ouanjli *et al.*, 2017). The principle operation of vector control technique is to control the torque and stator flux of respective motor independently through influencing the related field oriented quantities (Fig. 2).

Direct torque control method: Direct torque control is the most modern method that based on the Field Oriented

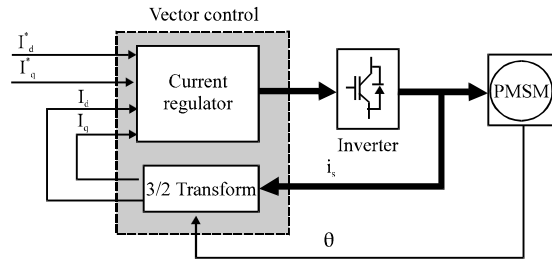

Fig. 2: Diagram of field oriented control method (Takahashi and Noguchi, 1986)

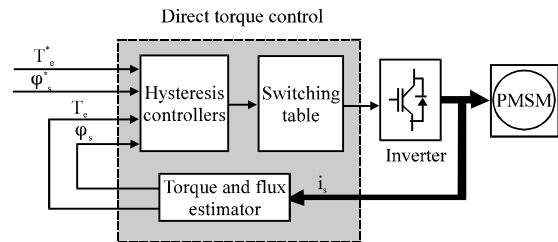

Fig. 3: Diagram of direct torque control method (Takahashi and Noguchi, 1986)

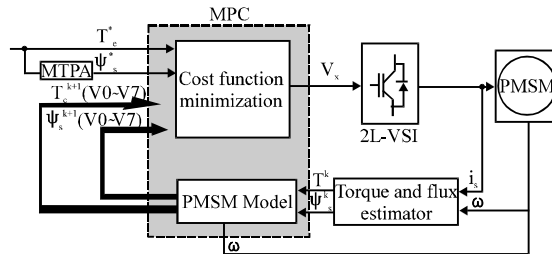

Fig. 4: Diagram of model predictive control method (Takahashi and Noguchi, 1986)

Control (FOC) and the direct self-control scheme has been realized in an industrial way by ABB during 1971-1985 by Depenbrok (Popescu, 2000). The main concept of this technique is to control stator flux and the torque by choosing the voltage space vectors appropriately that classical method is contingent on hysteresis controller as well as the switching table (Popescu, 2000) (Fig. 3).

Model predictive control method: Lately, model predictive control method has been employed in permanent magnet synchronous motor because it can provide noteworthy advantages over the FOC method, particularly with a uncomplicated controller tuning and considerable constraints handling (Takahashi and Noguchi, 1986). Figure 4 the main principle operation of this method is to forecast the behaviour of the variables over a specific time frame depend on the system model. It is worth mentioning that all prediction should be assessed depend on a

function of the cost. Subsequently, the prediction that can reduce the cost function is selected. Model predictive control method has substantial features including the easy inclusion constraints and nonlinearities (Takahashi and Noguchi, 1986).

RESULTS AND DISCUSSION

The Simulink model of the proposed PMSM with field oriented control and direct torque control methods has been implemented in MATLAB/Simulink environment as shown in the Fig. 5. All motor parameters and control parameters are shown in the Table 1. In the beginning, the motor starts under the reference speed set-point at 120 rad/s at no load. In fact it has been noticed that in the DTC simulation results the torque and flux have lower ripples as compared with FOC method at all load conditions as shown in the Fig. 5-28. Moreover, the findings show that also, the stator currents are higher stability in the steady state and very low ripple with compared FOC waveforms as shown in the Fig. 1-3. Furthermore, these figures show that the proposed system with FOC has low response and less matching reference speed. While DTC method in Fig. 4-6 shows that the respective system has fast response and good tracking with reference speed.

Table 1: Control parameters

PMSM parameters	Values	Units
Reference speed	120	Rad/sec
Reference torque	150	Nm
Flux	0.887	Wb
Voltage	400	V

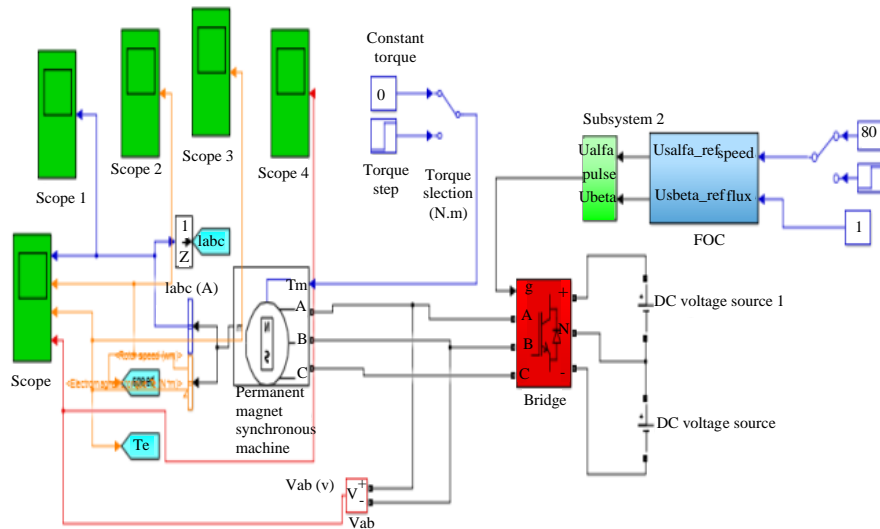

Fig. 5: PMSM Model

Figure 5-28 show that performance of permanent magnet synchronous motor with DTC and FOC methods under different load conditions.

DTC-SVM: In this case, the performance of PMSM has been tested at the presence of DTC-SVM under no-load, half load and full load conditions. It has been observed that speed has good response with respect to the reference speed that has been set at 120 rad/sec where speed approaches to steady state at 0.4 sec at all load conditions as shown in the figures. Also, torque has less ripple and good tracking with the reference torque that already has been set at 0.75 and 150 Nm. the torque reaches to the steady state case at 0.2 sec under all load conditions. Finally, the stator currents are more stable and less ripples compared with FOC method (7-17).

- DTC results at no-load
- DTC-SVM results at half load
- DTC-SVM results at full load condition

The results below show the impact of DTC on current, speed and torque.

FOC simulation results: In this case, the performance of PMSM has been tested at the presence of FOC-SVM under no-load, half load and full load conditions. It has been observed that speed has low response with respect to the reference speed that has been set at 120 rad/sec where speed approaches to steady state at 1s at no-load condition as shown in the Fig. 5-28. While in full load condition it takes more time to approach steady state situation. Also, torque has high ripple and mismatching

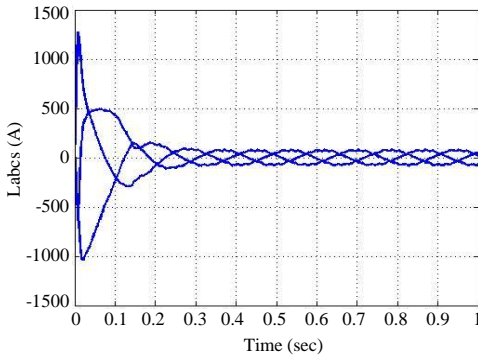

Fig. 6: Current waveform at no load

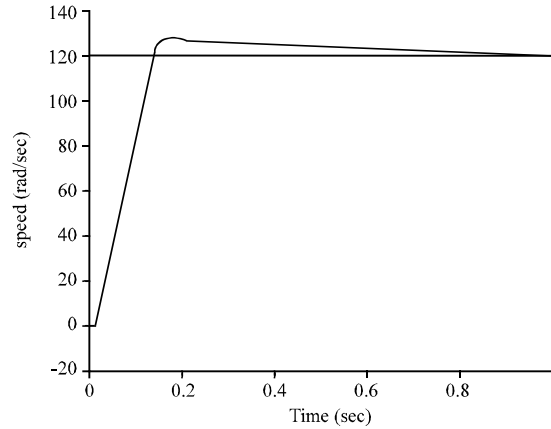

Fig. 9: Speed waveform at no load

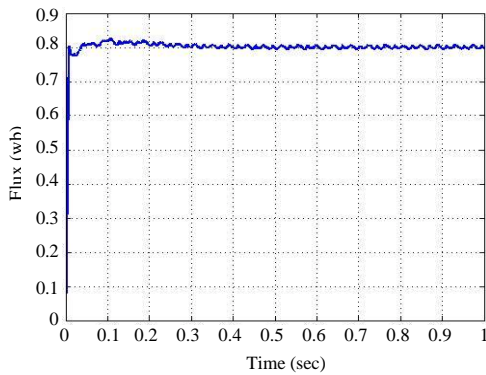

Fig. 7: Flux waveform at no load

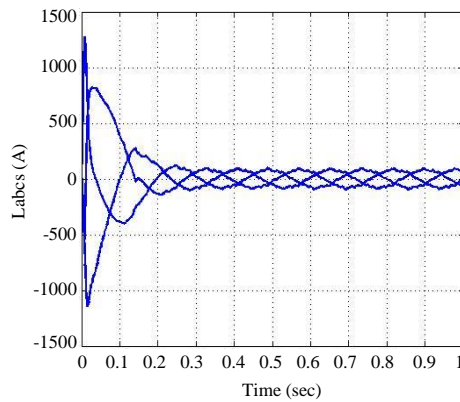

Fig. 10: Current waveform at half load condition

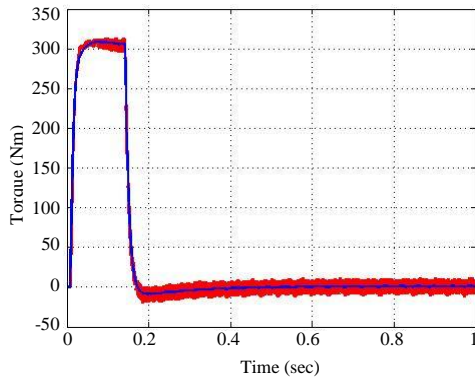

Fig. 8: Torque waveform at no load

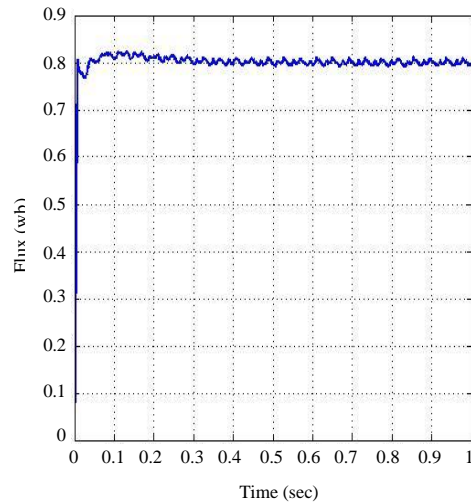

Fig. 11: Flux waveform at half load condition

with the reference torque that already has been set at 0.75 and 150 Nm. The torque reaches to the steady state case at 1 and 1.6 sec under no-load and half conditions respectively. While in full load condition, torque takes more than 1.6 sec to reach steady state situation as shown in the figures. Finally, the stator currents are less stable and high ripples compared with DTC-SVM method as shown in the Fig. 9-11 (Mynar *et al.*, 2016; Wang *et al.*, 2011).

- FOC simulation results at no load condition
- FOC simulation results at half load condition
- FOC simulation results at full load

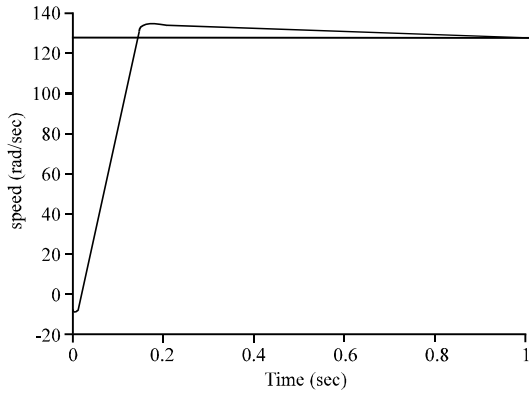

Fig. 12: Speed waveform at half load condition

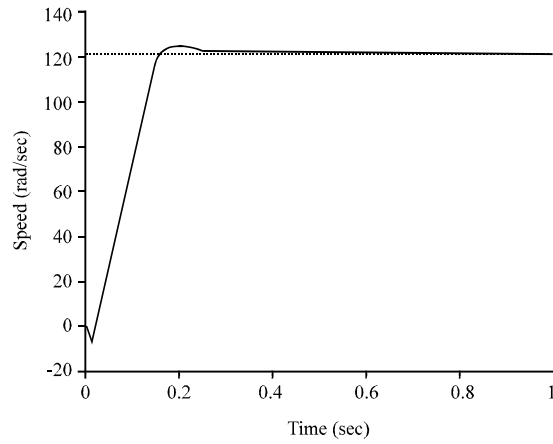

Fig. 16: Current waveform at full load condition

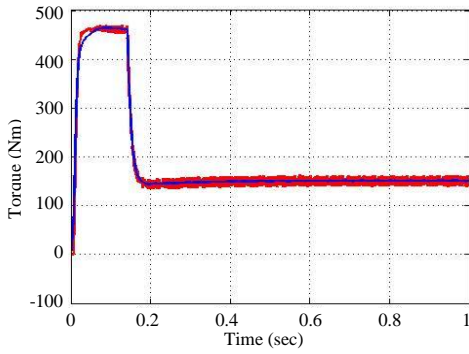

Fig. 13: Torque waveform at half load condition

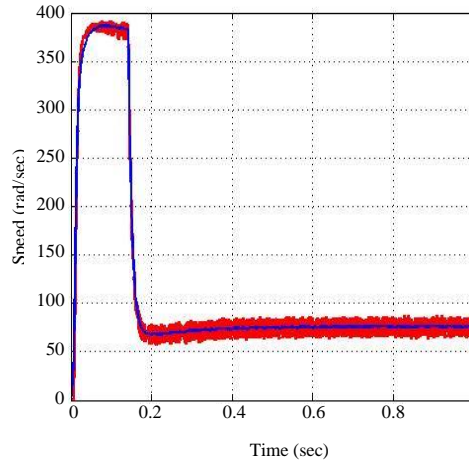

Fig. 17: Torque waveform at full load condition

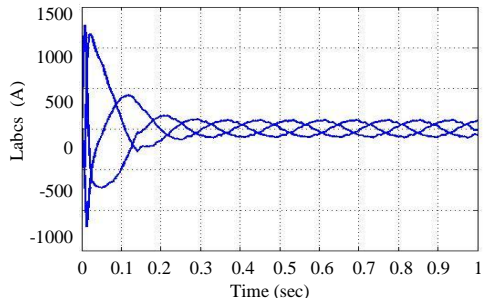

Fig. 14: Current waveform at full load condition

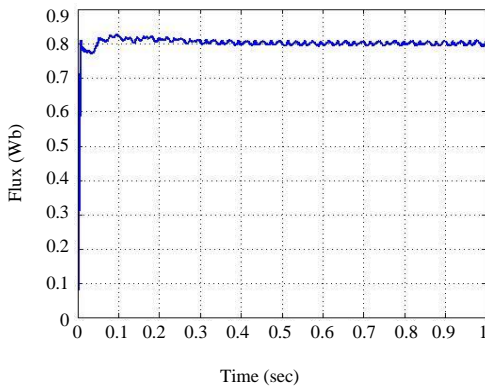

Fig. 15: Flux waveform at full load condition

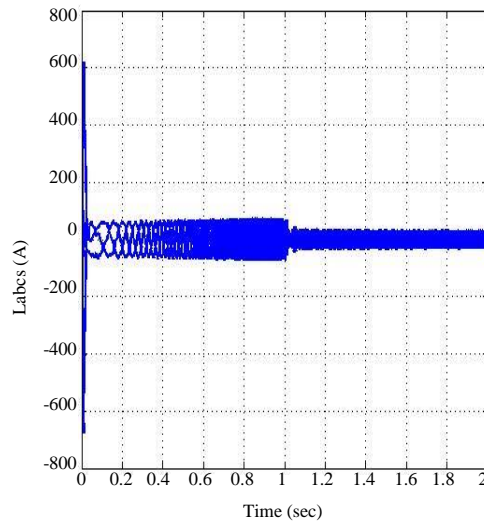

Fig. 18: Current waveform at no-load condition

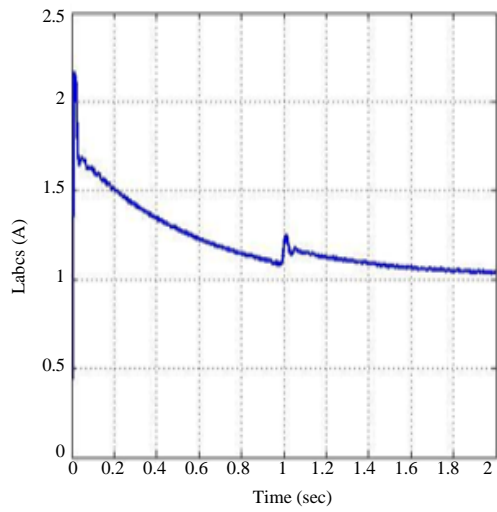

Fig. 19: Flux waveform at no load condition

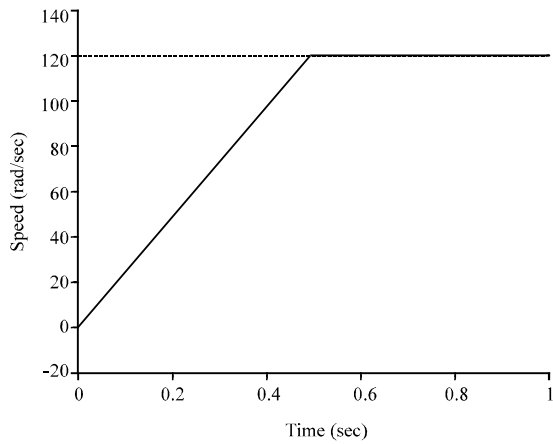

Fig. 20: Speed waveform at no load condition

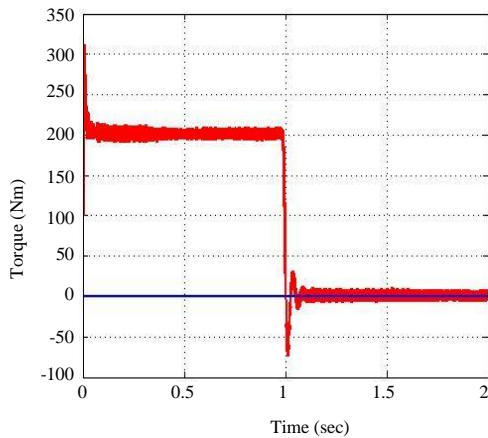

Fig. 21: Torque waveform at no load condition

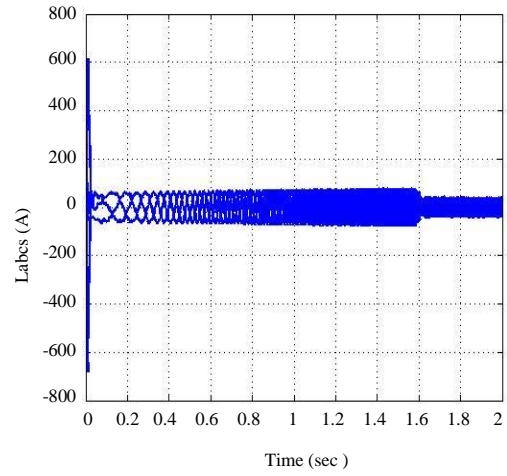

Fig. 22: Current waveform at half load condition

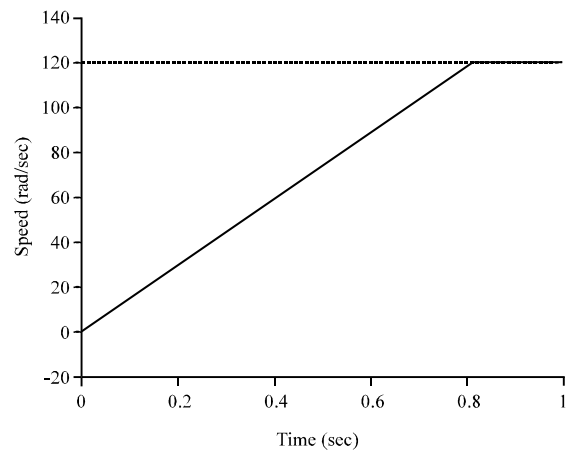

Fig. 23: Speed waveform at half load

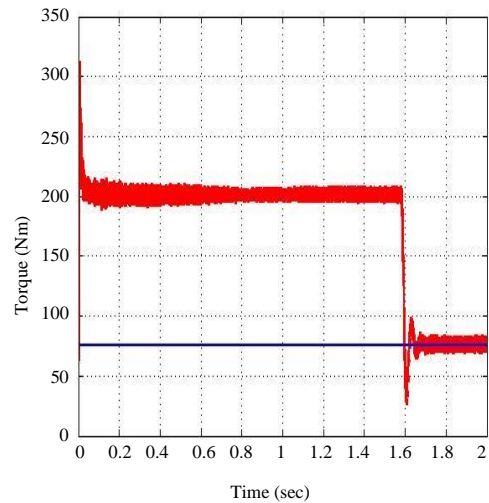

Fig. 24: Torque waveform at half load

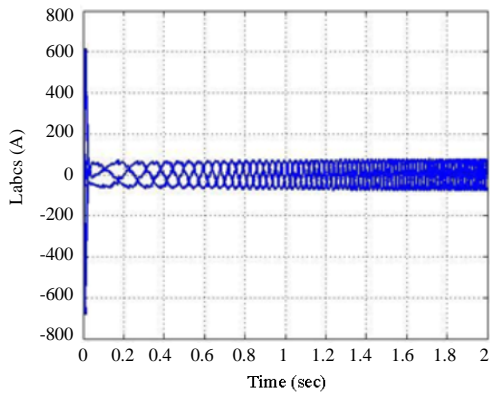

Fig. 25: Current waveform at full load condition

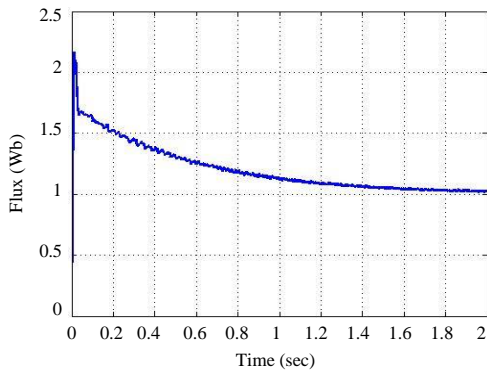

Fig. 26: Flux waveform at full load condition

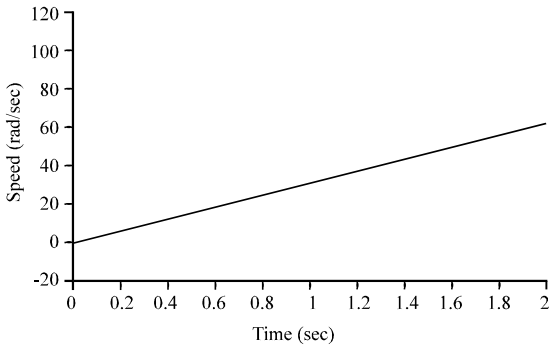

Fig. 27: Speed waveform at full load condition

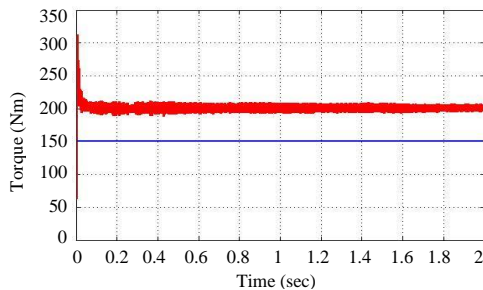

Fig. 28: Torque waveform at full load condition

CONCLUSION

Permanent magnet synchronous motors are commonly applied in numerous industrial areas with their high performance and field oriented control method has been used for long time, however, it is challenging to be applied in the low-cost system due its sophisticated system structure. Therefore, in this study, direct torque control method was proposed along with field oriented control to comprehend the impact of these techniques on permanent magnet synchronous motor and both techniques have been simulated in MATLAB/Simulink environment. The simulation findings illustrated that DTC exhibits better the dynamic performance of Permanent magnet synchronous motor including speed, torque and current compared to FOC method.

RECOMMENDATIONS

For future research, this study can be extended by applying model predictive control method into PMSM to comprehend the impact of all three techniques on its performance.

REFERENCES

- Behera, P.K., M.K. Behera and A.K. Sahoo, 2014. Speed control of induction motor using scalar control technique. *IJCA. Proc. Intl. Conf. Emergent Trends Comput. Commun.*, 1: 1-3.
- Bodson, M., J. Chiasson and R. Novotnak, 1998. High performance induction motor control via input-output linearization. *IEEE Control Syst. Magazine*, 14: 25-33.
- El Ouanjli, N., A. Derouich, A. El Ghzizal, A. Chebabhi and M. Taoussi, 2017. A comparative study between FOC and DTC control of the Doubly Fed Induction Motor (DFIM). *Proceedings of the 2017 International Conference on Electrical and Information Technologies (ICEIT'17)*, November 15-18, 2017, IEEE, Rabat, Morocco, ISBN:978-1-5386-1517-1, pp: 1-6.
- Kaewjinda, W. and M. Konghirun, 2007. Vector control drive of permanent magnet synchronous motor using resolver sensor. *ECTI. Trans. Electr. ENG. Electron. Commun.*, 5: 134-138.
- Kouro, S., P. Cortes, R. Vargas, U. Ammann and J. Rodriguez, 2009. Model predictive control-A simple and powerful method to control power converters. *IEEE. Trans. Ind. Electron.*, 56: 1826-1838.

- Krishna, D.S. and C.S. Rao, 2011. Speed control of permanent magnet synchronous motor based on direct torque control method. *Intl. J. Adv. Sci. Technol.*, 2: 63-88.
- Mynar, Z., L. Vesely and P. Vaclavek, 2016. PMSM model predictive control with field-weakening implementation. *IEEE. Trans. Ind. Electron.*, 63: 5156-5166.
- Panda, A., 2014. Direct torque control of permanent magnet synchronous motor. Ph.D Thesis, National Institutes of Technology Rourkela, Rourkela, India.
- Popescu, M., 2000. Induction Motor Modelling for Vector Control Purposes. Helsinki University of Technology, Espoo, Finland, ISBN:9789512252190, Pages: 144.
- Takahashi, I. and T. Noguchi, 1986. A new quick-response and high-efficiency control strategy of an induction motor. *IEEE. Trans. Ind. Appl.*, 5: 820-827.
- Wang, T.S., J.G. Zhu, Y.G. Guo, G. Lei and W. Xu, 2011. Simulation and experimental studies of permanent magnet synchronous motor control methods. *Proceedings of the 2011 International Conference on Applied Superconductivity and Electromagnetic Devices (ASEMD'11)*, December 14-16, 2011, IEEE, Sydney, Australia, ISBN:978-1-4244-7852-1, pp: 252-255.
- Zhang, Y., J. Zhu and W. Xu, 2010. Predictive torque control of permanent magnet synchronous motor drive with reduced switching frequency. *Proceedings of the 2010 International Conference on Electrical Machines and Systems (ICEMS'10)*, October 10-13, 2010, IEEE, Incheon, South Korea, ISBN:978-1-4244-7720-3, pp: 798-803.